

- ECM - Electronically Commutated Motor
- Ultra efficient
- Low power consumption
- Long life
- Continuous duty
- Variable speed
- Small footprint
- Very quiet
- Available in AC and DC power

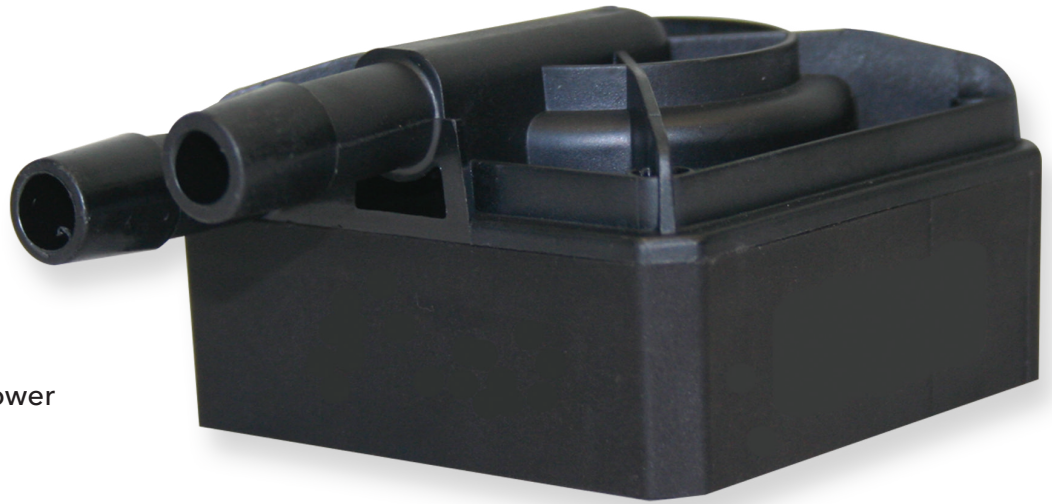

Laing Thermotech Series DDC Series

The Next Generation of Laser, Computer Cooling,
& Medical Pumps

ELECTRONICALLY COMMUTATED SPHERICAL MOTOR. 12 VOLT DC
CENTRIFUGAL PUMPS.

BR-23B

 **GOULDS**
WATER TECHNOLOGY
a xylem brand

DDC Series - The Next Generation of Laser, Computer Cooling, & Medical Pumps

Application

The Laing DDC is the world's first pump to be used in mass produced water-cooled workstations, and presents an ideal solution for liquid cooling of processors and electronic components. Besides numerous of Online-Mentions, the Laing DDC is also awarded with the Innovation Award of BadenWürttemberg, known as one of the most innovative regions in Germany and Europe. Due to its size and output, the Laing DDC can also be used in a large number of applications.

Design

The Laing DDC is an electronically commutated spherical motor pump, with an expected service life of 50,000 hours if pumping water or a mixture of water and glycol. **Please contact us regarding any other media requirements.*

The only moving part in a spherical motor pump is a spherically shaped rotor/impeller unit, which is seated on an ultra-hard, wear-resistant ceramic ball. The conventional shaft, shaft bearings and shaft seals have been eliminated.

The spherical bearing of the rotor/impeller unit on the ceramic ball offers a number of advantages. One such advantage is that the occurrence of bearing play and the

associated increase in noise is not possible due to the principle involved. Consequently, the pump continues to work quietly throughout its entire service life. The bearing is self-realigning. It is lubricated directly by the fluid being pumped (wet rotor design). This means that the pump is maintenance free. Since the rotor is always magnetically held in the designated position, small particles of dirt do not present a problem. Under normal conditions, it is impossible for the rotor to become locked. Reliable start is also ensured even after long periods of shutdown.

The permanent magnet rotor/impeller unit is driven by the magnetic field generated by the surrounding stator. The stator is wrapped entirely around the rotor. As a result, the entire pump is only slightly taller than the rotor itself, measuring only 1.5" in height, perfect for applications where space is limited.

The spherical motor design permits economical operation with comparatively high output. Supply voltage variation provides a simple means of controlling the speed of the DDC pump over a large output range. All parts in contact with the medium are 100% corrosion resistant. With an optional tachometer output, it is possible to monitor the speed of the pump directly.



DDC Series - Design

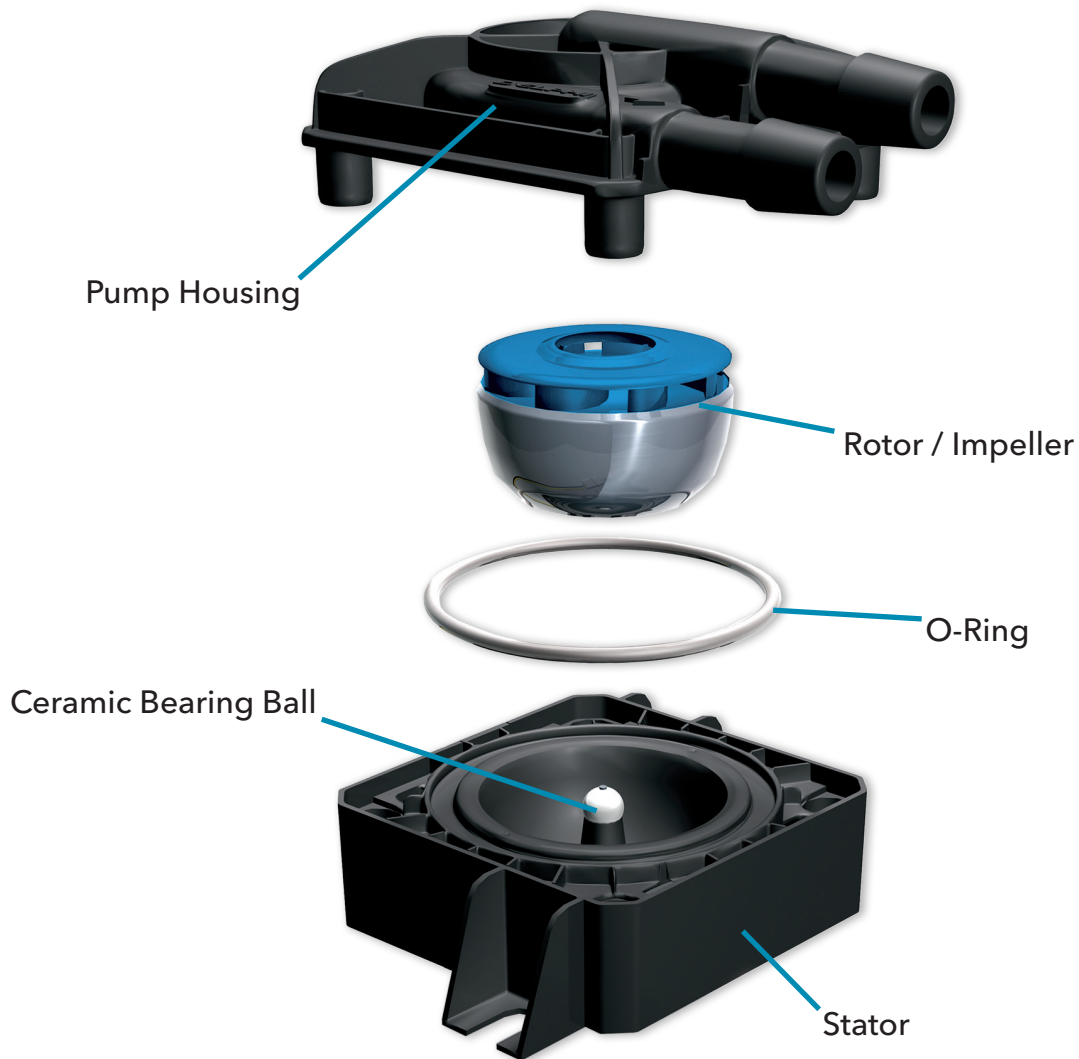

Technical Data

Motor design:	Electronically commutated spherical motor
Rated voltage:	12 Volt DC
Power consumption:	DDC 3.1: max. 12 Watt, DDC 3.15: max. 12 Watt, DDC 3.2: max. 18 Watt, DDC 3.25: max. 20 Watt
Voltage range:	8 to 13,2 Volt*
Acceptable media:	Water, Water-/Glycol Mixtures**, other media on request;
Max. system pressure:	21.75 PSI
Max. system temperature:	140° F
Wetted parts:	Rotor/impeller material: stainless steel grade 316Ti , PPS-GF40 is the pump housing material and the impeller, EPDM O-ring, aluminum oxide ceramic ball, carbon bearing cap
Electrical wire connection:	PA6.6 GF35

*Minimum startup Voltage 9 Volt

** Check pump performance for mixtures of 20% or more glycol

Dimensional Drawings

1/4" R Male Connection

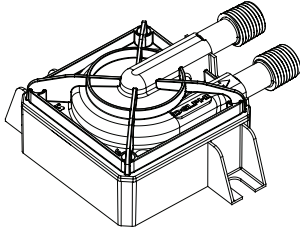
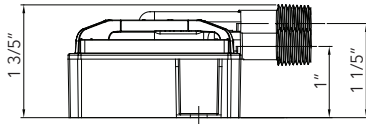

3/8" Hosebarb Connection

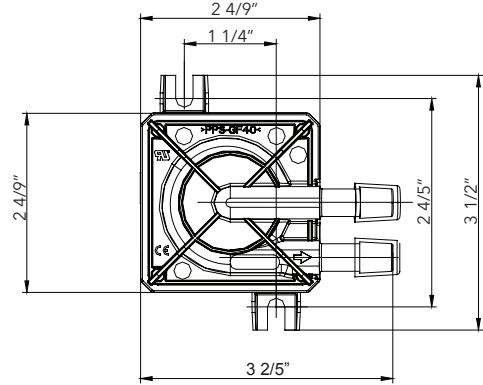
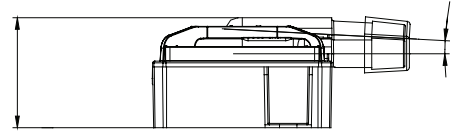
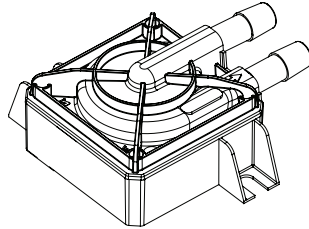
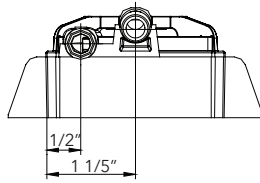

Center Suction

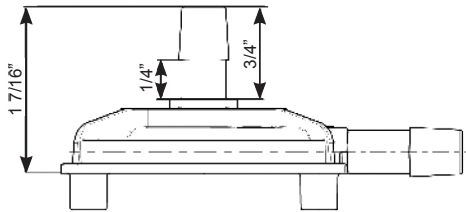

DDC Pump Family Curve

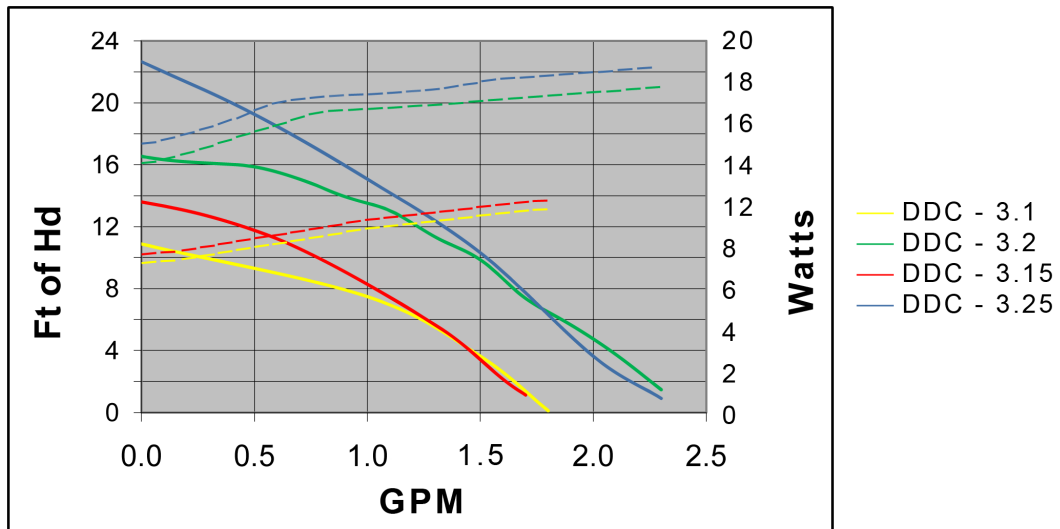

NOTE: The dashed lines represent power curves.



Xylem Inc.
 3878 S. Willow, Suite 104
 Fresno, CA 93725
 Tel: (559) 265-4730 (800) 554-6853
 Fax: (559) 265-4740 (800) 453-7523
www.Laing-thermotech.com

Goulds is a registered trademark of Goulds Pumps, Inc. and is used under license.
 © 2016 Xylem Inc. BR-23B June 2016